

360-degree Fisheye IP Camera

ICA-8000 Series

Quick Installation Guide

Table of Contents

Chapter 1. Introduction	3
1.1 Before Installation	3
1.2 System Requirements	3
Chapter 2. Physical Description and Installation.....	4
2.1 Package Contents	4
2.2 Physical Details	4
2.3 Installation.....	6
2.4 Wall/Ceiling Mount Installation Procedure.....	7
Chapter 3. Camera Windows Utility	8
3.1 Network Configuration	8
3.2 Opening the Web-based UI	10
Further Information	12

Chapter 1. Introduction

Thank you for purchasing PLANET ICA-8000 Fish-Eye Panorama IP Camera series. Its fish-eye lens has a 360-degree panoramic wide angle view without dead spots. With user-friendly interface, it is an easy-to-use IP camera designed for security application. The IP camera delivers a clear image, multiple H.264 streams and Motion JPEG streams.

The IP camera supports digital pan/tilt and zoom functions can provide users with 10 different video modes. It applies perspective correction software to eliminate the rounding normally associated with fish-eye lenses and thus saves lots of traditional mechanical pan/tilt maintenance cost.

It has a built-in ICR (IR-cut filter removable) for day / night surveillance and provides surveillance functions including DI/DO alarm, MicroSD card support for local storage, and 2-way audio that enables audio communication between local and remote sites by connecting the external microphone and speaker. Moreover, the IP camera can be managed by PLANET Cam Viewer IP Surveillance management software for multi-camera video surveillance application and provides monitoring, recording and event management functions to secure your property and life.

1.1 Before Installation

Before installation, please be sure to read this quick installation guide and user's manual (CD) carefully to complete machine installation. This guide shows how to quickly set up the IP camera.

1.2 System Requirements

CPU	Intel® Core™ i3 2.4GHz
RAM	4GB
Video RAM	1GB
Display Chip	nVIDIA GeForce 8500GT or ATI Radeon HD 4350 or above
Display Resolution	1366 x 768 24bits
Operating System	Windows XP with SP3 / Vista / Win7
DirectX	9.0c or above
Network	Wired Ethernet 100Base-TX

Chapter 2. Physical Description and Installation

2.1 Package Contents

- IP Camera Unit x 1
- Power Adapter x 1
- Quick Installation Guide x 1
- User's Manual CD x 1
- Wall Mount Kit x 1
- Mounting Label x 1
- GPIO Connector x 1

2.2 Physical Details

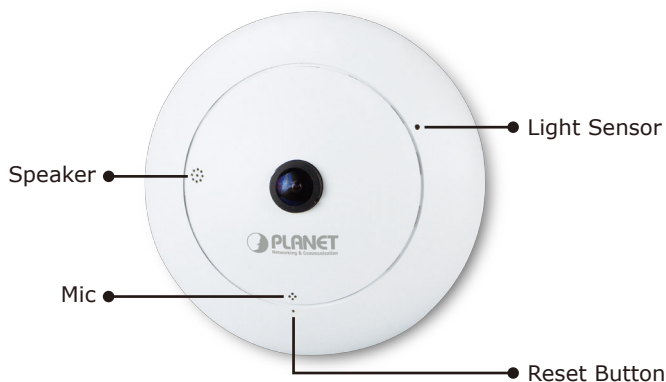

Front Panel

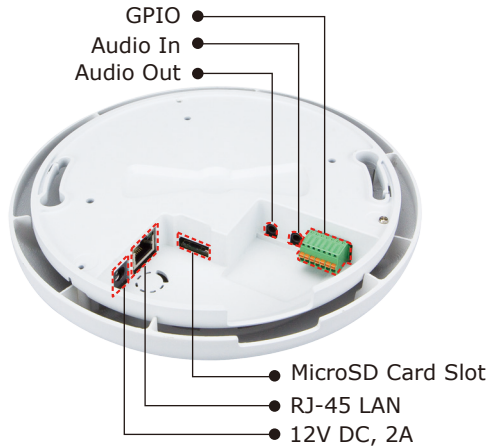

Interface	Description
Light Sensor	The Light sensor is for detecting the IP camera environment illuminance, and if the IP camera is in the dark/night environment, it will let IR cut filter off for a clear night view.
Mic	The IP camera has a built-in internal microphone which is hidden in the pinhole located on the front panel.
Reset Button	This button is hidden in the pinhole. Please refer to the user's manual for more information.
Speaker	The IP camera has a built-in internal speaker which is hidden in the pinhole located on the front panel.

Bottom Panel



Interface	Description
Power Jack	<p>The input power is 12V DC, 2A.</p> <div style="border: 1px solid black; padding: 5px;">  <p>Note ONLY use the power adapter that comes with the package. Otherwise, the product may be damaged.</p> </div>
RJ-45 LAN Socket	<p>Connect to PC or Hub/Switch. It connects to 10Base-T Ethernet or 100Base-TX Fast Ethernet cabling. This Ethernet port built auto-negotiation protocol can detect or negotiate the transmission speed of the network automatically. Please use CAT-5 cable to connect the Network Camera to a 100Mbps Fast Ethernet network switch or hub.</p> <div style="border: 1px solid black; padding: 5px;">  <p>Note ONLY use one power source, either from DC or from 802.3af Power over Ethernet. (For ICA-8200/ICA-8500 only)</p> </div>
MicroSD Card Slot	<p>The IP camera has a built-in MicroSD card slot for MicroSD memory card for image / video event recording.</p>
Audio Out	<p>Connect a loud speaker to the IP camera. This is for voice alert and two-way audio.</p>
Audio In	<p>Connect a microphone to the IP camera.</p>
GPIO	<p>The 7-pin terminal block includes 1 input port and 2 output ports.</p>

Terminal block for I/O connectors:

Pin	Function	Description
1	GND	Digital Input: Only one set is designed in this camera model. The internal device is also a photo-coupled electrical relay, and the external device can be simply an On/Off switch. Each set of On/Off switch can be connected as one trigger source.
2	DI	
3	GND	
4	DO_COM	Digital Output: Each digital output pin to COM is a photo-coupled relay on Normal Open status. External device can directly connect to the terminals. However, the current that will go through the 2 nodes must not exceed 130mA. An external "Relay" can also be connected to the terminals as an implementation. In this case, current (or/and voltage) limitation is specified by the external Relay.
5	DO_NO2	
6	DO_COM	
7	DO_NO1	

2.3 Installation

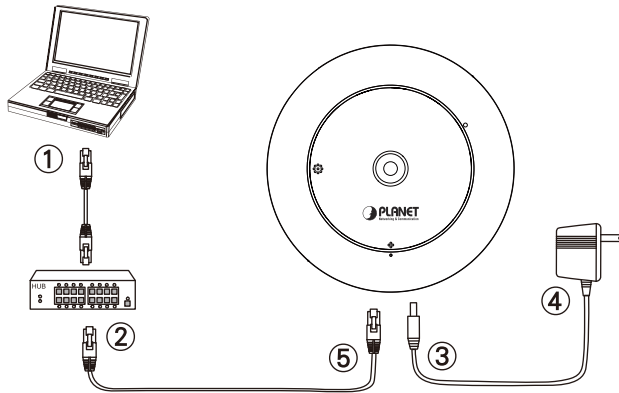

Step 1. Prepare a PC with Ethernet link to the network

Step 2. Connect an Ethernet cable

Connect LAN port (RJ-45) of the IP camera to a network switch. For ICA-8200/ICA-8500, when this switch is a PoE device, you can ignore the next step.



Note

For ICA-8000 series, if there has an IEEE 802.3af PoE switch in your network, you can connect the IP camera's LAN cable to this PoE switch to obtain power. The power adapter is unnecessary when the IP camera is powered by PoE switch.

Step 3. Attach the power supply

Plug the power adapter in the IP camera and connect the other end to the power outlet.



Only use the power adapter supplied with the IP camera; otherwise, the product may be damaged.

Step 4. Plug Power on 100V ~ 240V

Ensure the power adaptor specification matches the power system (100 ~ 110V AC or 220 ~ 240V AC) and connect the adaptor to the outlet.

Step 5. Check LED status

The Power LED is defined to identify the IP camera status. When the IP camera is booting, the LED will flash, and while the IP camera is ready, the LED will be green.

Step 6. Adjust lens focus

Clockwise or counter-clockwise rotation can be adjusted for the focus of the IP camera lens.

2.4 Wall/Ceiling Mount Installation Procedure

Step 1. Stick the given mounting label at the installation location.

Step 2. Take the wall mount bracket, put it on the target place and fix it with the supplied screws (total of 2).

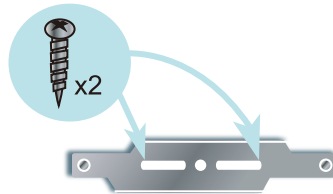

Step 3. Load the camera into the wall mount. Be sure the camera is mated with two fixed screws, and rotate the camera clockwise to lock it in position.

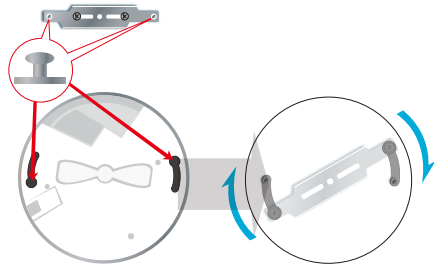

Chapter 3. Camera Windows Utility

This chapter shows how to quickly set up your IP camera. The IP camera is with the default settings. However, to help you find the networked IP camera quickly, the Windows utility (PLANET IPInstaller) can search the IP camera in the network that can help you to configure some basic setting before you start advanced management and monitoring.

Please insert the bundled CD disk into your CD/DVD-ROM drive. When the welcome web page appears, please click your IP camera name on the IP camera list, i.e. ICA-8000 series. Then click on the utility IPInstaller to start the program.

3.1 Network Configuration

Please click the “**Search Network Device**” button. PLANET IPInstaller will list the networked IP camera in the LAN. If the IP camera cannot be found, you may check whether this IP camera is connected to the network properly and press the search button again.

1. Click the menu bar **Device Search** to search the device in the LAN.

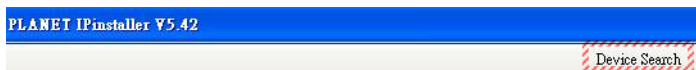

2. Select the IP camera with the MAC address corresponding to the IP camera that is to be configured.

Device Search				
Model Name	IP Address	MACAddress	Firmware	SubnetMask
ICA-8500	192.168.0.020	00-30-4f-37-5f-01	09.9_1107_PLANET	255.255.255.0

3. Double-click the item to open the Property Page or click the menu bar **Property**.

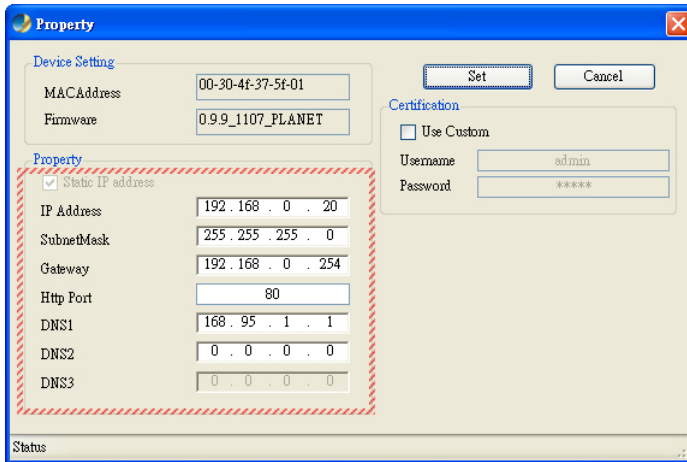

4. After filling the desired settings in the properties, click on **"Set"** button to complete the configuration settings.

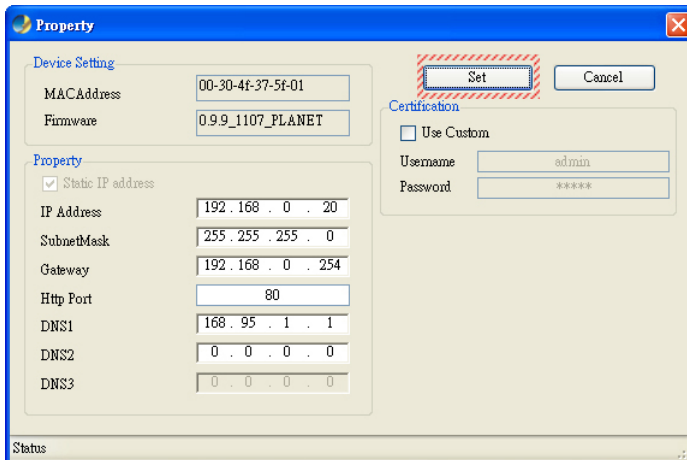

3.2 Opening the Web-based UI

If IPInstaller finds the IP camera, please select the device you want to view and click the **"Open Web"** button. Then you could see the video from the IP camera directly.

1. To access the Web-based UI of the selected unit, run the **Open Web** on the menu bar.

IP Address	MACAddress	Firmware	SubnetMask
192.168.0.020	08:00:14:07:50:04	0.0.0.1107_PLANET	255.255.255.0
192.168.1.035		25	255.255.255.0
192.168.1.224		planet	255.255.255.0
192.168.1.011		planet	255.255.255.0
192.168.1.009		planet	255.255.255.0

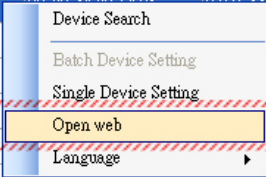

2. After connecting to the IP camera, it will prompt for User Name and Password. Please enter admin/admin to continue Web Management. Confirm the installation as it is required to view the video stream and some operations.

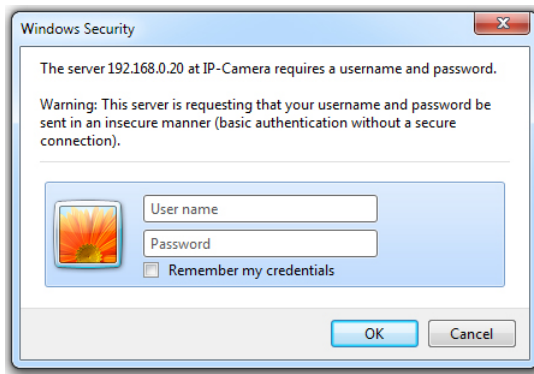

If difficulty is met, please refer to the following steps to establish the connection:

- The IP camera must be installed and powered ON.
- If the IP camera's default IP address (**192.168.0.20**) is already used by another device, the other device must be turned OFF until the device locates a new IP address during the configuration.

3. For the first installation, there will be a prompt to install the ActiveX control.



4. If the device has been configured correctly, the default Web browser will open to the home page of the selected device.



Further Information

This guide is used to help you start-up your Fish-Eye IP Camera settings. It is also recommended to check the user manual in CD disk for more details of the system and user configuration.